

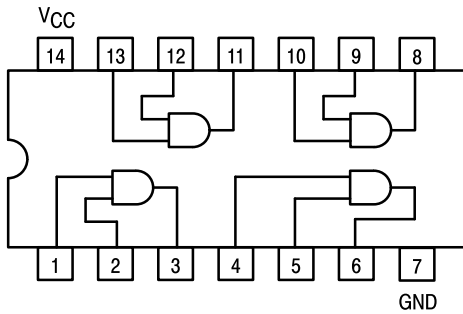

# QUAD 2-INPUT AND GATE



**SN54/74LS08**

**QUAD 2-INPUT AND GATE  
LOW POWER SCHOTTKY**

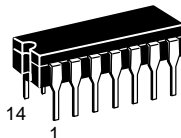

**J SUFFIX**  
CERAMIC  
CASE 632-08

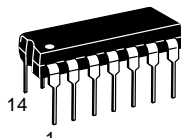

**N SUFFIX**  
PLASTIC  
CASE 646-06

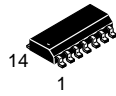

**D SUFFIX**  
SOIC  
CASE 751A-02

**ORDERING INFORMATION**

SN54LSXXJ	Ceramic
SN74LSXXN	Plastic
SN74LSXXD	SOIC

## GUARANTEED OPERATING RANGES

Symbol	Parameter		Min	Typ	Max	Unit
V <sub>CC</sub>	Supply Voltage	54	4.5	5.0	5.5	V
		74	4.75	5.0	5.25	
T <sub>A</sub>	Operating Ambient Temperature Range	54	-55	25	125	°C
		74	0	25	70	
I <sub>OH</sub>	Output Current — High	54, 74			-0.4	mA
I <sub>OL</sub>	Output Current — Low	54			4.0	mA
		74			8.0	

# SN54/74LS08

## DC CHARACTERISTICS OVER OPERATING TEMPERATURE RANGE (unless otherwise specified)

Symbol	Parameter	Limits			Unit	Test Conditions	
		Min	Typ	Max			
$V_{IH}$	Input HIGH Voltage	2.0			V	Guaranteed Input HIGH Voltage for All Inputs	
$V_{IL}$	Input LOW Voltage	54		0.7	V	Guaranteed Input LOW Voltage for All Inputs	
		74		0.8			
$V_{IK}$	Input Clamp Diode Voltage		-0.65	-1.5	V	$V_{CC} = \text{MIN}$ , $I_{IN} = -18 \text{ mA}$	
$V_{OH}$	Output HIGH Voltage	54	2.5	3.5	V	$V_{CC} = \text{MIN}$ , $I_{OH} = \text{MAX}$ , $V_{IN} = V_{IH}$ or $V_{IL}$ per Truth Table	
		74	2.7	3.5	V		
$V_{OL}$	Output LOW Voltage	54, 74		0.25	0.4	V	$I_{OL} = 4.0 \text{ mA}$ $V_{CC} = V_{CC} \text{ MIN}$ , $V_{IN} = V_{IL}$ or $V_{IH}$ per Truth Table
		74		0.35	0.5	V	
$I_{IH}$	Input HIGH Current			20	$\mu\text{A}$	$V_{CC} = \text{MAX}$ , $V_{IN} = 2.7 \text{ V}$	
				0.1	mA	$V_{CC} = \text{MAX}$ , $V_{IN} = 7.0 \text{ V}$	
$I_{IL}$	Input LOW Current			-0.4	mA	$V_{CC} = \text{MAX}$ , $V_{IN} = 0.4 \text{ V}$	
$I_{OS}$	Short Circuit Current (Note 1)	-20		-100	mA	$V_{CC} = \text{MAX}$	
$I_{CC}$	Power Supply Current Total, Output HIGH			4.8	mA	$V_{CC} = \text{MAX}$	
	Total, Output LOW			8.8			

Note 1: Not more than one output should be shorted at a time, nor for more than 1 second.

## AC CHARACTERISTICS ( $T_A = 25^\circ\text{C}$ )

Symbol	Parameter	Limits			Unit	Test Conditions
		Min	Typ	Max		
$t_{PLH}$	Turn-Off Delay, Input to Output		8.0	15	ns	$V_{CC} = 5.0 \text{ V}$ $C_L = 15 \text{ pF}$
$t_{PHL}$	Turn-On Delay, Input to Output		10	20	ns	

**Case 751A-02 D Suffix  
14-Pin Plastic  
SO-14**

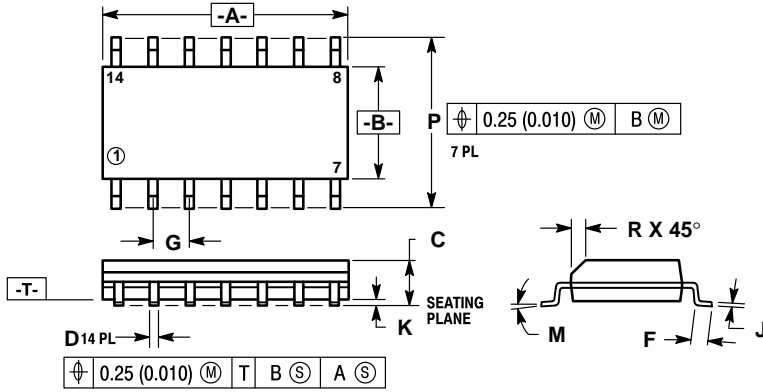

- NOTES:
1. DIMENSIONS "A" AND "B" ARE DATUMS AND "T" IS A DATUM SURFACE.
  2. DIMENSIONING AND TOLERANCING PER ANSI Y14.5M, 1982.
  3. CONTROLLING DIMENSION: MILLIMETER.
  4. DIMENSION A AND B DO NOT INCLUDE MOLD PROTRUSION.
  5. MAXIMUM MOLD PROTRUSION 0.15 (0.006) PER SIDE.
  6. 751A-01 IS OBSOLETE, NEW STANDARD 751A-02.

DIM	MILLIMETERS		INCHES	
	MIN	MAX	MIN	MAX
A	8.55	8.75	0.337	0.344
B	3.80	4.00	0.150	0.157
C	1.35	1.75	0.054	0.068
D	0.35	0.49	0.014	0.019
F	0.40	1.25	0.016	0.049
G	1.27 BSC		0.050 BSC	
J	0.19	0.25	0.008	0.009
K	0.10	0.25	0.004	0.009
M	0°	7°	0°	7°
P	5.80	6.20	0.229	0.244
R	0.25	0.50	0.010	0.019

**Case 632-08 J Suffix  
14-Pin Ceramic Dual In-Line**

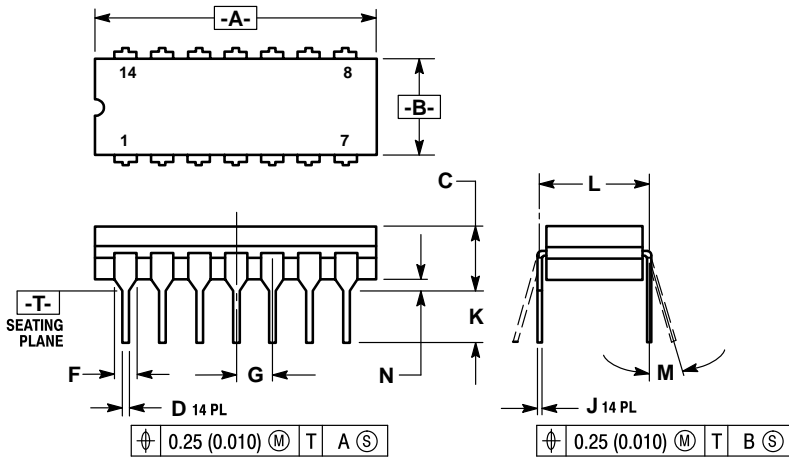

- NOTES:
1. DIMENSIONING AND TOLERANCING PER ANSI Y14.5M, 1982.
  2. CONTROLLING DIMENSION: INCH.
  3. DIMENSION L TO CENTER OF LEAD WHEN FORMED PARALLEL.
  4. DIM F MAY NARROW TO 0.76 (0.030) WHERE THE LEAD ENTERS THE CERAMIC BODY.
  5. 632-01 THRU -07 OBSOLETE, NEW STANDARD 632-08.

DIM	MILLIMETERS		INCHES	
	MIN	MAX	MIN	MAX
A	19.05	19.94	0.750	0.785
B	6.23	7.11	0.245	0.280
C	3.94	5.08	0.155	0.200
D	0.39	0.50	0.015	0.020
F	1.40	1.65	0.055	0.065
G	2.54 BSC		0.100 BSC	
J	0.21	0.38	0.008	0.015
K	3.18	4.31	0.125	0.170
L	7.62 BSC		0.300 BSC	
M	0°	15°	0°	15°
N	0.51	1.01	0.020	0.040

**Case 646-06 N Suffix  
14-Pin Plastic**

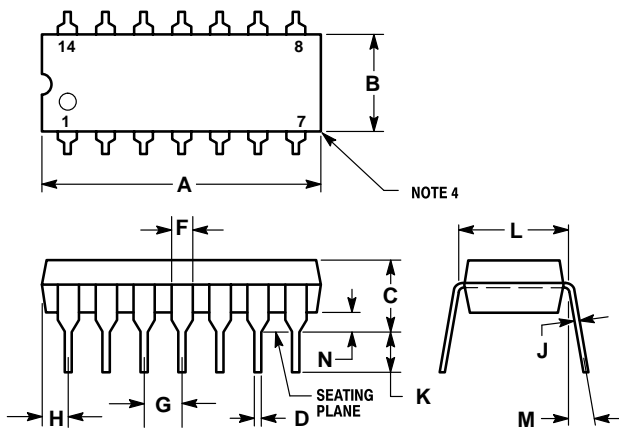

- NOTES:
1. LEADS WITHIN 0.13 mm (0.005) RADIUS OF TRUE POSITION AT SEATING PLANE AT MAXIMUM MATERIAL CONDITION.
  2. DIMENSION "L" TO CENTER OF LEADS WHEN FORMED PARALLEL.
  3. DIMENSION "B" DOES NOT INCLUDE MOLD FLASH.
  4. ROUNDED CORNERS OPTIONAL.
  5. 646-05 OBSOLETE, NEW STANDARD 646-06.

DIM	MILLIMETERS		INCHES	
	MIN	MAX	MIN	MAX
A	18.16	19.56	0.715	0.770
B	6.10	6.60	0.240	0.260
C	3.69	4.69	0.145	0.185
D	0.38	0.53	0.015	0.021
F	1.02	1.78	0.040	0.070
G	2.54 BSC		0.100 BSC	
H	1.32	2.41	0.052	0.095
J	0.20	0.38	0.008	0.015
K	2.92	3.43	0.115	0.135
L	7.62 BSC		0.300 BSC	
M	0°	10°	0°	10°
N	0.39	1.01	0.015	0.039

Motorola reserves the right to make changes without further notice to any products herein. Motorola makes no warranty, representation or guarantee regarding the suitability of its products for any particular purpose, nor does Motorola assume any liability arising out of the application or use of any product or circuit, and specifically disclaims any and all liability, including without limitation consequential or incidental damages. "Typical" parameters can and do vary in different applications. All operating parameters, including "Typicals" must be validated for each customer application by customer's technical experts. Motorola does not convey any license under its patent rights nor the rights of others. Motorola products are not designed, intended, or authorized for use as components in systems intended for surgical implant into the body, or other applications intended to support or sustain life, or for any other application in which the failure of the Motorola product could create a situation where personal injury or death may occur. Should Buyer purchase or use Motorola products for any such unintended or unauthorized application, Buyer shall indemnify and hold Motorola and its officers, employees, subsidiaries, affiliates, and distributors harmless against all claims, costs, damages, and expenses, and reasonable attorney fees arising out of, directly or indirectly, any claim of personal injury or death associated with such unintended or unauthorized use, even if such claim alleges that Motorola was negligent regarding the design or manufacture of the part. Motorola and <sup>TM</sup> are registered trademarks of Motorola, Inc. Motorola, Inc. is an Equal Opportunity/Affirmative Action Employer.

**Literature Distribution Centers:**

USA: Motorola Literature Distribution; P.O. Box 20912; Phoenix, Arizona 85036.

EUROPE: Motorola Ltd.; European Literature Centre; 88 Tanners Drive, Blakelands, Milton Keynes, MK14 5BP, England.

JAPAN: Nippon Motorola Ltd.; 4-32-1, Nishi-Gotanda, Shinagawa-ku, Tokyo 141, Japan.

ASIA PACIFIC: Motorola Semiconductors H.K. Ltd.; Silicon Harbour Center, No. 2 Dai King Street, Tai Po Industrial Estate, Tai Po, N.T., Hong Kong.



This datasheet has been download from:

[www.datasheetcatalog.com](http://www.datasheetcatalog.com)

Datasheets for electronics components.